

nobilia[®]

Interior organisation



**STORAGE SPACE
WITH ME IN MIND**



PERFECTLY ORGANISE EVERYDAY LIFE

Is there anything better than a well-organised home? With intelligent interior organisation and plenty of good ideas, you can design your kitchen to be nice and tidy. Our objective: storage space with me in mind. We focus entirely on what's inside, regardless of the size of the kitchen. What's the best way to structure and optimise storage space in a large or smaller kitchen? What does a drawer need to be capable of? Are there any sustainable and hygienic options for dealing with waste and recycling? We have just the right solution for any question – and a whole host of detailed, forward-looking ideas. Discover how our diverse selection can further optimise interior organisation on a daily basis.

Enjoy!

PERFECTION IN FORM AND FUNCTION

n144
the living system

Storage solutions require space and structure, which is why we plan each and every element from the very start – for a kitchen that not only looks good, but also makes processes convenient and efficient. Our grid system, the Living System, provides consistent, harmonious lines that form the visual hallmark of our kitchens, and is based on our drawer measuring 144 mm in height, which is tall enough to stow away larger kitchen utensils and slim enough to ensure an elegant design. The height of each additional unit in our range is based on this smallest of dimensions, resulting in a uniform joint pattern, as all the elements fit flawlessly together.

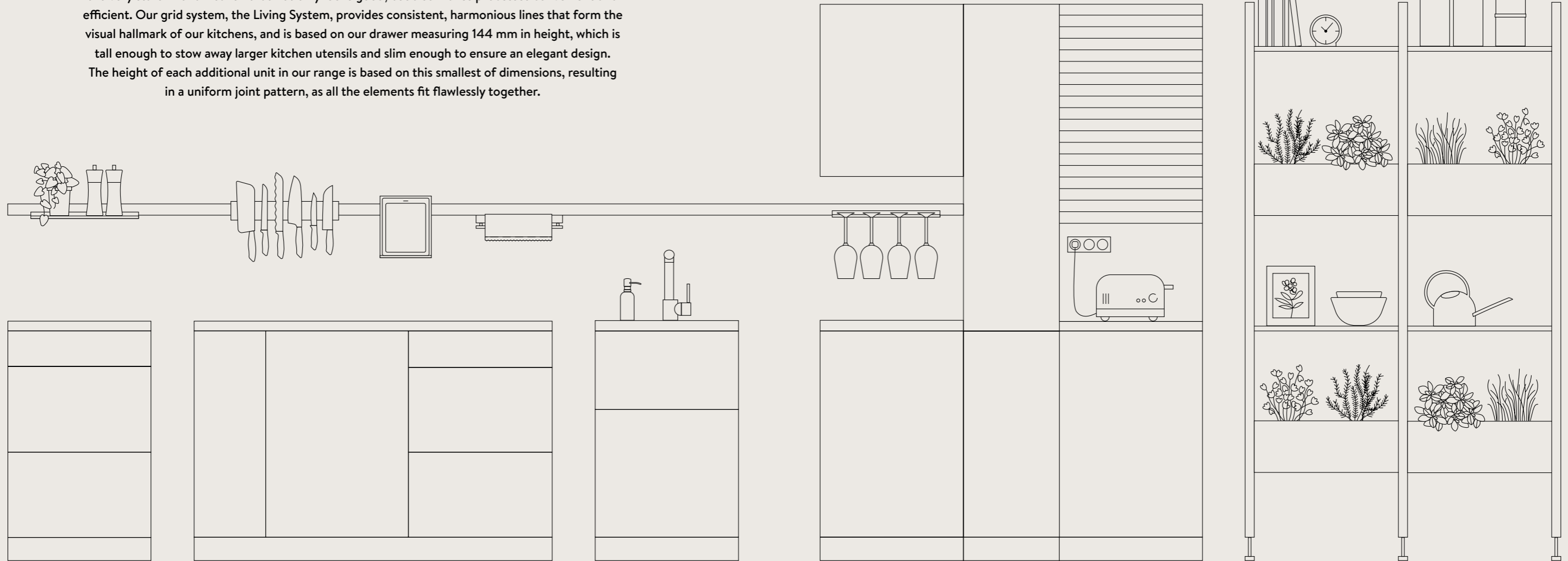

01

SYSTEMATIC ORGANISATION

Cutlery trays
Universal organisers
Pull-out organisers

P. 08 – 29

02

EVERYTHING AT A GLANCE

Pull-out units
Corner unit solutions

P. 30 – 37

03

NEATLY STRUCTURED, OPTIMALLY ORGANISED

Waste separation systems
Organisation systems
for base units

P. 38 – 43

04

ALWAYS WITHIN EASY REACH

Wall unit solutions
Tall units with internal pull-outs
Larder units
Access doors

P. 44 – 51

05

ADDITIONS FOR CUSTOMISATION

Pole-mounted shelving system
Railing systems
Lighting
Practical additions

P. 52 – 66

THE RIGHT SOLUTION FOR ANY PROBLEM

Whether your kitchen is big or small, sophisticated structures are sure to simplify everyday life. Our ideas and must-haves ensure plenty of storage space even in smaller rooms. And just like that, we provide you with a whole host of new opportunities for using every last corner.



STORAGE SPACE DOWN TO THE LAST CORNER

More is possible than you might think. Niche shelves, corner unit solutions and our railing systems will work wonders for your storage space, as even the smallest of areas offer room. More about our practical additions from page 52.



NO STORAGE SPACE? NOT A PROBLEM.

Larder units can handle it all. Whether big or small, this pull-out system uses space effectively and provides convenient access to utensils and foods on both sides. Storage space that's accommodating all round. More about our tall unit solutions from page 46.



BYE BYE, CHAOS!

A clear overview at a glance. The organisation systems for drawers and pull-outs keep everything tidy and where it belongs. A large selection of inserts and sets offer a suitable solution for every drawer and pull-out size – for example, as a combination of fixed and flexible dividers. All drawer and pull-out solutions are available from page 8.





01 — SYSTEMATIC ORGANISATION

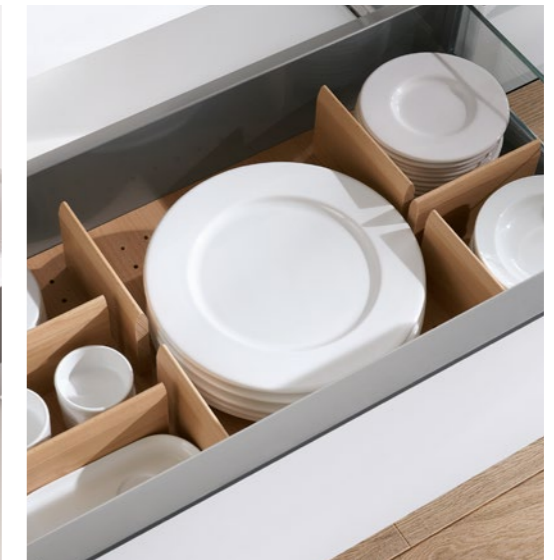

Are you tired of the chaos of typical drawers? Simply focus on what's inside. Cutlery trays and practical organisation systems can now structure the interior of cabinets and pull-outs, always taking your needs into account.



THE AESTHETIC SIDE OF ORGANISATION

Plastic or genuine wood? It's entirely up to you. Organise your drawers with a structure that meets your personal needs and reflects your everyday life. Our organisation elements make the best use of your kitchen. Take advantage of our versatile range of equipment elements and enjoy the perfect solution every day.



PLASTIC CUTLERY TRAYS

Easy-care design! Black plastic cutlery trays are especially practical and hygienic. The Concept and Black Edition cutlery trays also boast a soft-touch finish that prevents them from slipping around, so everything stays where it belongs.



**TIDY AND VISUALLY
AESTHETIC CUTLERY
TRAYS WITH
ELEMENTS FOR
CUTLERY, KNIVES,
SPICES AND MORE.**

**CUTLERY TRAYS
IN BLACK ASH**

Genuine wood with black glaze for truly exclusive aesthetics. Does elegant tone-on-tone equipment tickle your fancy? Complement the cutlery trays in black ash with the matching storage containers and spice mills.



**CUTLERY TRAYS
IN BEECH AND OAK**

Perfectly organised, naturally. Made from genuine beech or oak, the cutlery trays boast an aesthetic, durable and robust design as well as extraordinary quality that stands out from the very first glance. The oak design also offers a non-slip mat.



OUR TIP

Save time and begin cooking straightaway without having to rummage around for herbs, knives, whisks and more. A place for everything and everything in its place. The drawer below the hot plate is a good example.



**FOLLOWER MECHANISM
FOR INTERNAL DRAWERS**

Make it easier than ever to access the internal drawer. As you pull out the front pull-out, simply pull out the internal drawer at the same time. With the press of a finger, you can unlock the follower mechanism and freely move the drawer.



Concept cutlery tray with knife block

PLASTIC

Move cutlery tray

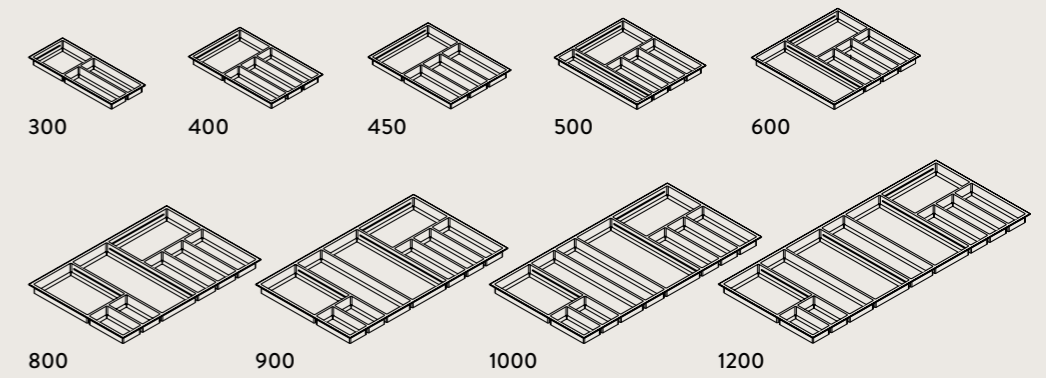

All sizes available for drawer depths of 400 and 500 mm. With dividers for customisable divisions.

Concept cutlery tray

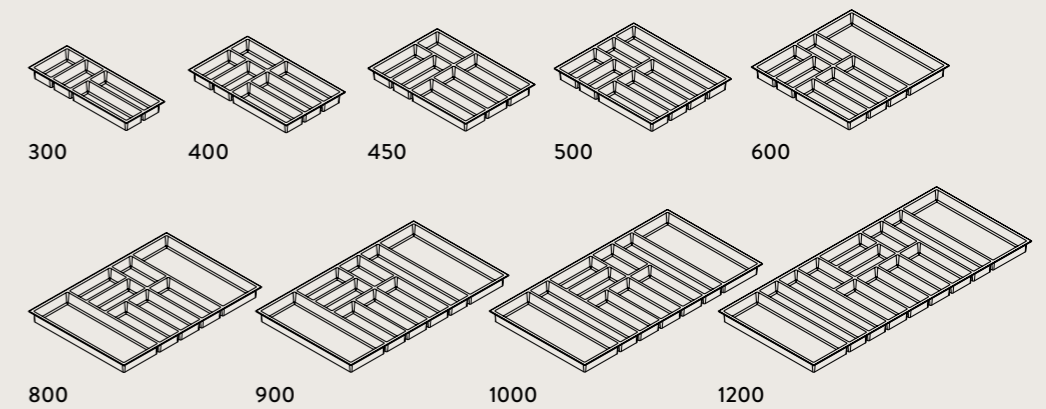

Equipment elements

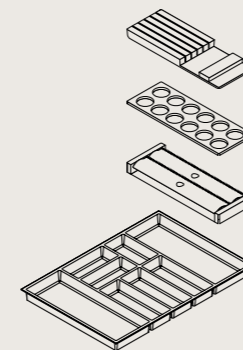

For drawer sizes of 800 mm or larger, customers can choose a cutlery tray with a knife block, an insert for spice jars or an insert for cling wrap cutter. The equipment elements are not available individually or for the Black Edition.

Black Edition cutlery tray

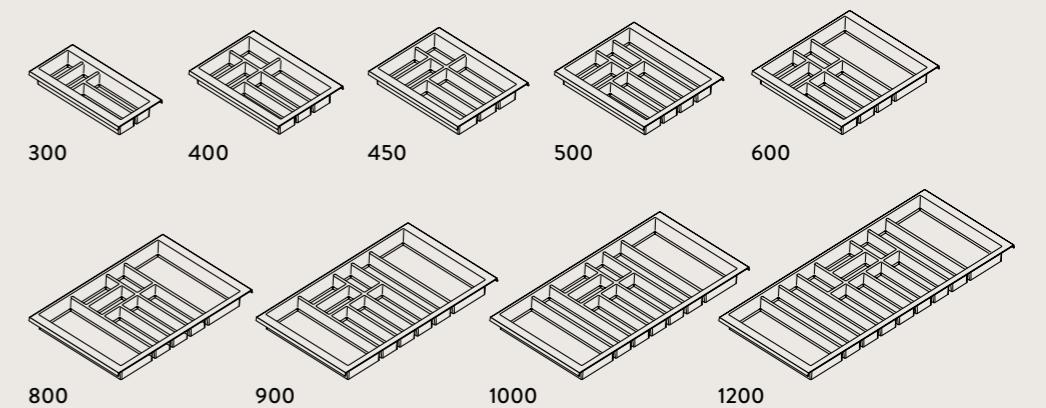



Oak wood cutlery tray with knife block

BEECH

Beech wood cutlery tray

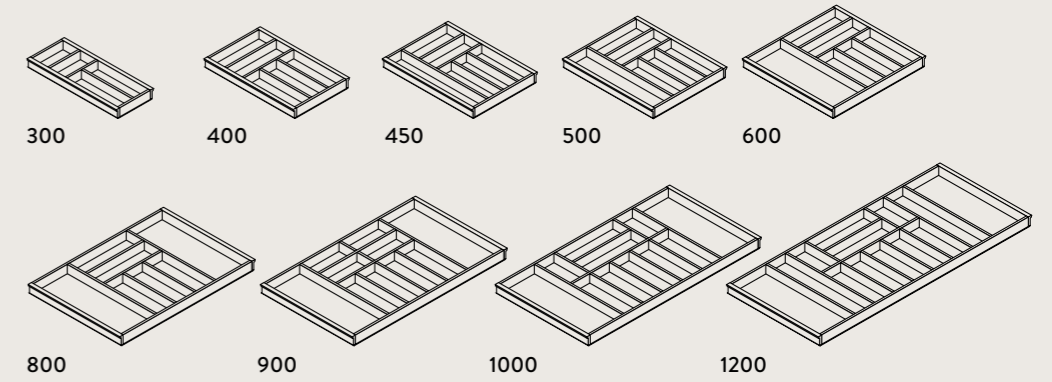

OAK

Oak wood cutlery tray

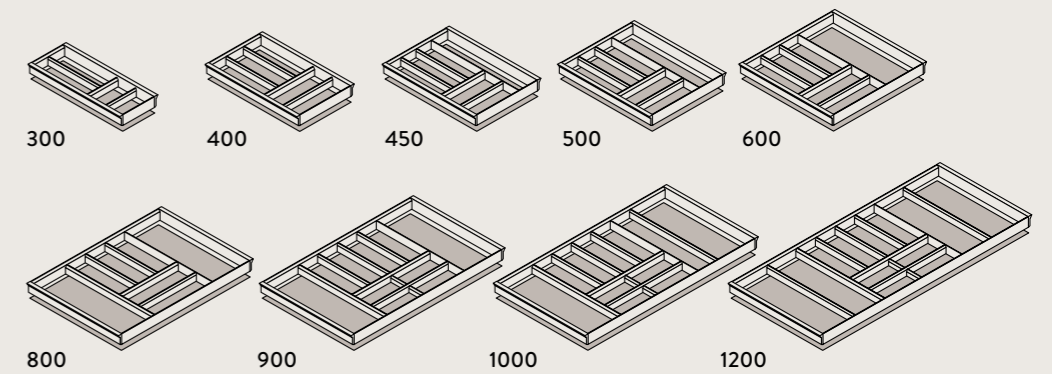

All sizes available for drawer depths of 400 and 500 mm.

Also available as a wood segment cutlery tray with non-slip mat for drawer depths of 400 and 500 mm with widths between 400 and 1,200 mm.

Equipment elements

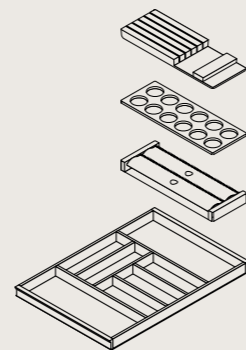

For drawer sizes of 800 mm or larger, customers can choose a cutlery tray with a knife block, an insert for spice jars or an insert for cling wrap cutter. The equipment elements are not available individually.

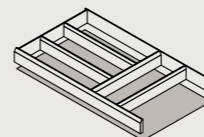



BLACK ASH

Black ash wood cutlery tray

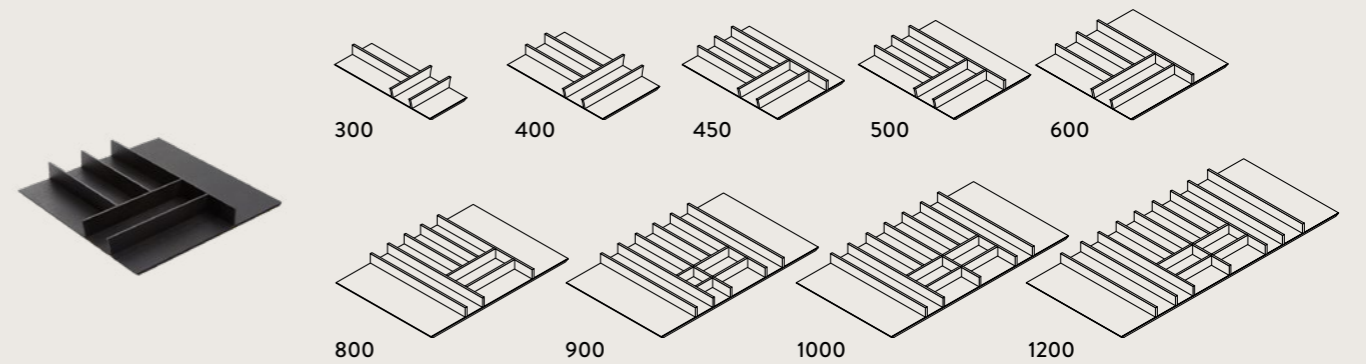

Equipment elements



For a drawer size of 600 mm, customers can choose a cutlery tray with a knife block, including knives, or an insert for spice mills and shakers, including mills and shakers.

The cutlery tray is also available as a set with additional storage containers for drawer sizes of 800 mm or larger.

The equipment elements are not available individually.

Black ash wood cutlery tray with knife block and small storage containers

nobilis



FULLY CUSTOMISED: SIMPLE AND UNCOMPLICATED

The best recipe for organisation is inner divider systems for perfectly structured drawers and pull-outs. Our universal organisers offer plenty of space and are divided into compartments, offering a tidy overview at all times. Available in numerous variants and designs which can be adapted to meet your needs.



UNIVERSAL ORGANISERS IN PLASTIC

How practical! Plus, they're easy to care for and highly durable. Dividers for width and depth provide a structured overview of dishes and storage containers. Successful examples include our Concept pull-out organiser with fixed dividers and our plastic divider with adjustable aluminium profiles.



OUR TIP

Our universal organisers make it easier than ever to create clear structures that will integrate visually into your kitchen regardless of the style.



**UNIVERSAL ORGANISERS
IN BEECH AND OAK**

Tidy and visually aesthetic! Pots and lids as well as dishes can be organised next to each other or stacked for a clear overview. Our drawers and pull-outs are not only highly robust, but also look good.



**UNIVERSAL ORGANISERS
IN BLACK ASH**

Organisation that makes a statement! Combined with glazed woods such as ash, the all-in-black design radiates top quality. Finish off the look with our matching storage containers in black.

**CUSTOMISE
YOUR PULL-OUTS
IN NO TIME WITH
WOOD PARTITIONS
AND PEGS**



OUR TIP

Say goodbye to rattling and clanking!
Non-slip mats reduced noise and ensure that pots and other utensils stay in place. Our mats are suitable for a drawer depth of 500 mm, but can also be cut to size.





Concept pull-out organiser

PLASTIC

Concept pull-out organiser

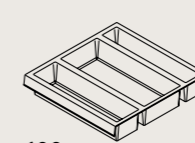

600

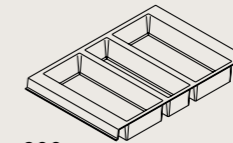

800

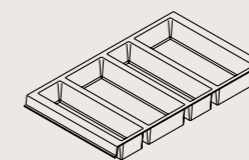

900

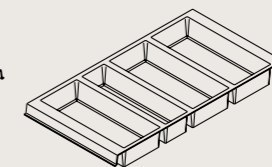

1000

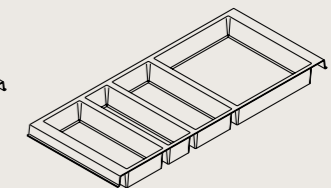

1200

Universal organiser

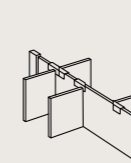
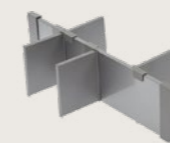

1 aluminium profile for 600 mm width

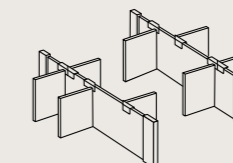

2 aluminium profiles for 800 to 900 mm width

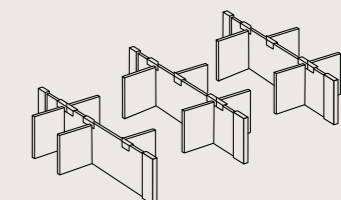

3 aluminium profiles for 1,000 to 1,200 mm width

Please order the correct number for the unit width.



Beech universal organiser with solid wood pegs and partitions

BEECH, OAK AND BLACK ASH

Material variants for solid wood partitions and pegs

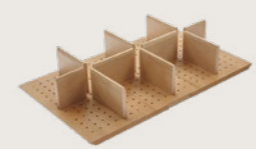

Beech



Oak



Black ash

Universal organisers



Solid wood partitions

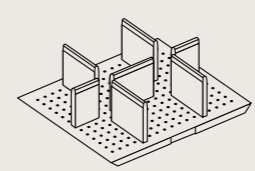

Incl. 7 partitions for 600 mm width

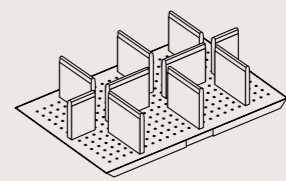

Incl. 10 partitions for 800 to 1,000 mm width

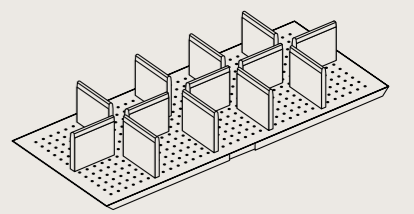

Incl. 13 partitions for 1,200 mm width



Solid wood pegs

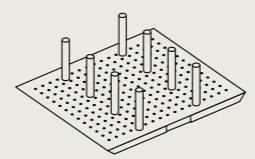

Incl. 8 pegs for 600 mm width

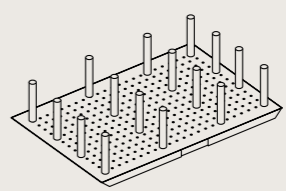

Incl. 16 pegs for 800 to 1,000 mm width

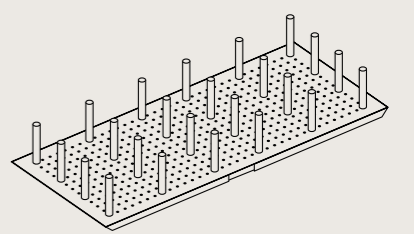

Incl. 24 pegs for 1,200 mm width

Also available as a set of 8.

Extension with storage containers for black ash



Solid wood partitions and storage containers

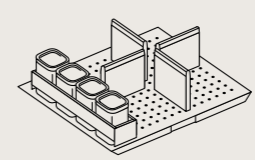

Incl. 4 partitions for 600 to 900 mm width

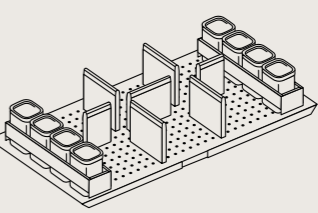

Incl. 7 partitions for 1,000 mm width

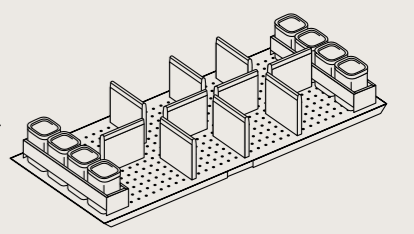

Incl. 10 partitions for 1,200 mm width

With 4 storage containers for 600 mm width.
With 8 storage containers for 800 to 1,200 mm width.

PRACTICAL PULL-OUTS FOR GREATER CONVENIENCE

Organise everything in a flash with the greatest convenience. Pull-outs are wonderfully functional and can even help sensibly organise storage spaces in larger kitchens – with adjustable dividers. And sometimes with a surprisingly sustainable solution, as even our Gardening Box fits perfectly into a pull-out.



SPACEFLEXX

The customisable organisation system for storage containers and kitchen utensils keeps drawers nice and tidy. Flexible dividers bring structure to every pull-out. Nothing tips over or falls out, and you can find what you need straightaway. SpaceFlexx® can be integrated into any drawer with a front width of 60 cm or more. The wonderfully versatile and flexible nesttex® Inside divider adapts specifically to the contours and size of the stored goods and can also be cleaned in the washing machine for convenience.



OUR TIP

The small organic garden in a drawer is a wonderful idea for people who prefer things a little greener.

The Gardening Box offers the perfect solution to grow healthy microgreens yourself. A variety of microgreens are applied to seed mats on four trays. Young, edible seedlings that are ideal for fresh and healthy nutrition.

The practical Gardening Box features grow lights and ventilation, which control the plants' day and night cycle. The plants can be harvested after 7 to 10 days – simply monitor growth with the app.



PANTRY BOX

Wonderfully stored and always within easy reach. This sturdy Pantry Box contains a shelf with drain and ventilation slots and a small carrying caddy, which is ideal for storing vegetables and baked goods and keeping them fresh. Made from tempered glass, the hygienic sliding cover also protects food when the draw is closed, offering yet another benefit.



02 — EVERYTHING AT A GLANCE



Some solutions simply make the best of everyday life in the kitchen!
 Just a quick glance and the work can begin. Pull-out systems
 and corner unit solutions in base units offer plenty of potential and space
 for pots, bowls and anything else you'd like to have within easy reach.

SOLUTIONS THAT ACCOMMODATE YOUR NEEDS

It's so practical when the kitchen can relieve you of some of your work. Rummaging around in the cabinets is a thing of the past, now that the kitchen utensils are here to assist you. Our pull-out and corner unit systems always provide convenient access.



PULL-OUT SYSTEMS

With everything so well organised on multiple levels, you can reach food or kitchen utensils with the greatest of ease. The practical, customisable organisation systems like the Junior larder pull-out feature adjustable hanging baskets, which you can access directly from any side regardless of where you are.



OUR TIP

Systematic organisation is always a good idea. Our customisable UBOXX organiser system offers dividers and compartments in a variety of sizes and heights, so you have the space to store it all. Structure the system in a way that meets your everyday needs.



EXPLOIT CORNER SPACE WITH SWIVEL TABLARS, WHICH PROVIDE ACCESS TO POTS, PANS AND BOWLS.

EXPLOITING CORNER SPACE

There's really no need for this shape to lead a marginal existence, as it can provide unused space with real added value. Highboard or traditional solution? Add a little movement to your storage space and enjoy convenience and structure every day.





Junior larder pull-out

FUNCTIONAL PULL-OUTS

For 150 and 200 mm width



Pull-out unit with towel rail



Pull-out unit with 2 metal baskets



Pull-out unit with baking tray holder

For 300 mm width



Pull-out unit with internal drawers and removable metal bottle rack



Junior larder pull-out, UBOXX organiser system, divider for knives and cutting board holder



Junior larder pull-out with two adjustable hanging baskets



Pull-out unit with recyclable materials collector for 40-litre recycling sack



Pull-out unit with baguette bag

CORNER UNITS



Everything at a glance

Half corner unit with wooden rotary shelves

Diagonal corner units



Diagonal carousel unit with wooden rotary shelves and metal railing



Diagonal corner unit with shelves



Diagonal wall unit with revolving carousel featuring wooden rotary shelves and metal railing

Corner units



Carousel corner unit with wooden rotary shelves and metal railing

Half corner units



Half corner unit with swivel pull-out



Half corner unit with wooden rotary shelves

Corner highboards



Corner highboard with swivel pull-outs

All our corner units, diagonal corner units and half corner units are available with shelves.



03 — NEATLY STRUCTURED, OPTIMALLY ORGANISED



Waste is an issue in every household and, of course, in society. Our aim is as little as necessary and as effectively separated as possible. And this is precisely where we can help, with our sophisticated selection of waste separation systems for base units and sinks.



Neatly structured, optimally organised

Separato waste separation system

WASTE SEPARATION SYSTEMS

With waste separation for pull-out units



300 mm width
1x 20 litres/1x 10 litres, 1 bio lid
400 mm width
1x 20 litres/2x 10 litres, 1 bio lid



600 mm width
1x 15 litres/2x 7 litres, 1 bio lid
1 utensil holder, 3 compartment dividers



600 mm width
1x 20 litres/2x 10 litres, 1 bio lid,
1 utensil holder, 3 compartment dividers

With recyclable materials collector for pull-out units



300 mm width
1 metal bin with lid for recycling sack,
40 litres

Euro-Cargo waste separation system for pull-out units



450/500 mm width
2x 38 litres



600 mm width
2x 38 litres/1x 12 litres/1x 2.5 litres,
1 bio lid

Many different things come together in every kitchen, including fruit and vegetables, fresh and packaged foods, and quite a bit of waste of different kinds. Where does it belong? Our practical waste separation systems can be integrated into pull-out units and sink base units and offer sustainable options for hygienic separation.



Neatly structured, optimally organised

Separato-K waste separation system

Cargo frame waste separation system for sink units



450 mm width
2x 14 litres
500 mm width
1x 20 litres/1x 12 litres
600 mm width
1x 20 litres/2x 10 litres, 1 bio lid

Separato-K waste separation system for sink units



450 mm width
1x 18 litres/2x 8 litres, 1 bio lid

Separato-M waste separation system for sink units



500 mm width
1x 18 litres/2x 8 litres,
1 side organiser, 1 bio lid
600 mm width
1x 18 litres/2x 8 litres,
2 side organisers, 1 bio lid

Separato-M waste separation system for sink units



450 mm width
2x 20 litres
500 mm width
2x 24 litres
600 mm width
2x 28 litres

Separato waste separation system for sink units



600 mm width
2x 14 litres/1x 4 litres separated in the top pull-out, 1 organisation element at the back, 1 utensil tray



800 mm width
2x 14 litres/1x 4 litres, 1 organisation element at the back, 1 bio lid, 3 utensil trays



900 mm width
2x 14 litres/1x 4 litres, 1 organisation element at the back, 1 bio lid, 1 dustpan and brush set, 2 utensil trays



1,000 mm width
3x 14 litres, 1 organisation element at the back, 1 bio lid, 1 dustpan and brush set, 2 utensil trays
1,200 mm width
4x 14 litres, 1 organisation element at the back, 1 bio lid, 1 dustpan and brush set, 2 utensil trays



04 — ALWAYS WITHIN EASY REACH



Things always seem to accumulate in everyday life. You can never have enough space, which is why we've developed a versatile range of storage options in tall and wall units which not only enrich life, but also provide structure.

HIGHLY STRUCTURED TALL UNITS

They exist – space miracles that create more space than they take up. One of these is undoubtedly tall units, which can be integrated into kitchen planning in many different shapes and boast attributes that are sure to surprise the moment the door is opened.



PANTRIES

Enjoy wonderfully convenient storage space solutions with our larder unit or the Cargo pantry, which provide you with simple access to foods. Outstanding! Everything is visible at all times – you simply need to grab it.



ORGANISATION SYSTEMS

Where do you put the ironing board, the broom and cleaning equipment? We offer a diverse range of freely configurable organisation systems for tall units that allow you to stow away just about everything with ease, which is perfect when you don't have a utility room.



HOUSING FOR RAISED WASHING MACHINES

We offer you the TÜV-certified housing for built-in washing machines. Winning arguments: loading and unloading is wonderfully convenient and, thanks to special shock absorbers and a frame design, the washing machine stays exactly where it's supposed to, even during the fastest spin cycle. The stylish way to integrate a washing machine.



OUR TIP

Special holders provide space to store multiple bottle crates in a tall unit. You'll also be glad to hear that you can install up to 3 holders in a single unit, each with a capacity of up to 35 kg. A convenient solution for those who don't have a basement.

ORGANISATION SYSTEMS FOR TALL UNITS



Always within easy reach

Tall unit with internal pull-outs



Tall unit with internal pull-outs



Cargo pantry



Tall unit with larder pull-out



Tall unit for bottle crates



Tall unit with Laundry-Area laundry basket tablar



Broom and appliance cupboard



Laundry-Area organisational system



Housing for washing machine/dryer

EXPAND YOUR OPPORTUNITIES

There are plenty of options for optimal use of space behind skilfully positioned sliding and access doors and inside wall units, which also offer plenty of design options. For example, they can serve as an elegant form of storage space, connect rooms or discreetly conceal what you'd rather keep hidden.



ACCESS DOORS

An access door in a tall unit format allows you to design additional areas or rooms in the same charming look as that of your kitchen. Just close the door to conceal everything behind it. You can even hide smaller pantries and utility rooms behind access doors that visually complement your kitchen to perfection. Available in single and double-leaf designs.



SLIDING DOORS

Always a tidy impression. Integrated into the kitchen's design concept, selected areas or rooms can be cunningly concealed with large-format sliding doors.



SPICE RACK

Always maintain a clear overview! The wall unit is sure to surprise with an integrated spice rack, which offers space for up to 24 spice jars. The complementary 6 canisters are perfect for noodles, flour and sugar.



iMOVE

What a great idea! iMove can transform a traditional wall unit into an ergonomic storage system, with a practical benefit: you can also use and conveniently access higher areas of the unit.



OUR TIP

A good mantra: use all the space. It's often the little things that make all the difference. Take, for example, movable and ergonomic helpers, which allow you to make full use of the higher areas of the units.

PLATE RACK FOR COTTAGE STYLE KITCHENS

Charming! Plate racks embody the country look and can transform your favourite plates into decorations. A wonderful idea for the kitchen or even the dining area.





05 — ADDITIONS FOR CUSTOMISATION

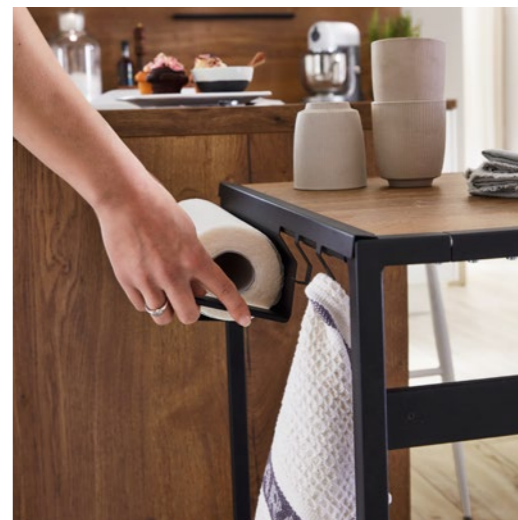

Everyone approaches organisation differently. What type of organiser are you? Creative and relaxed, highly structured or extremely precise? Our additions for customisation offer a whole host of ideas for adding your own personal touch to organisation – with shelf units, railing systems and new equipment options.



POLE-MOUNTED SHELVING SYSTEM

Aluminium support poles

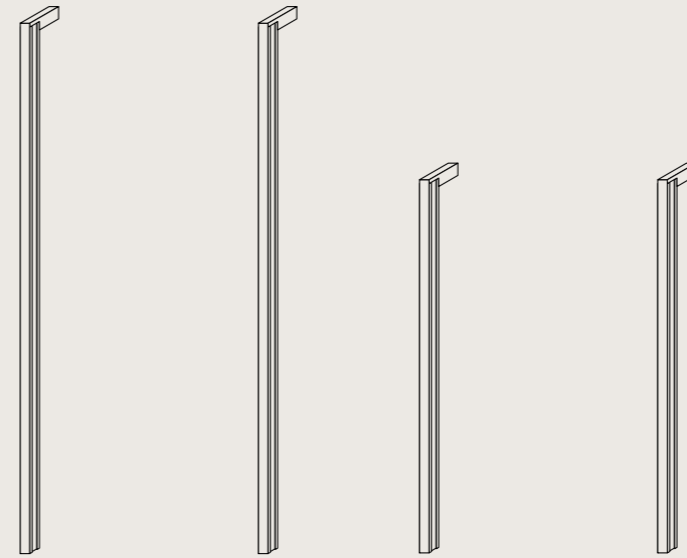

Support poles in tall unit height

Support poles in highboard height

Available support pole colours: black and stainless steel finish.
Available with optional LED light design.

Shelves and inserts



Shelf, 220 mm deep,
16 or 25 mm thick

Also available with a depth of 380 mm.

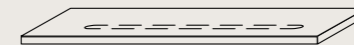

Shelf with Manila Plus
LED built-in light

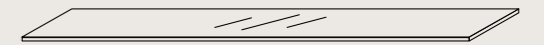

Glass shelf, 220 mm deep,
8 mm thick

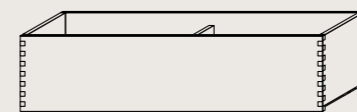

Wooden box,
150 mm tall, 170 mm deep

Also available with a height of 70 mm.



Herb pots for wooden box,
125 mm tall, 148.5 mm deep

Also available with a height of 45 mm.

Pull-out and wall units can also be
combined with pole-mounted shelving.

Three cheers for customisation options! Whether in the living room, the dining area or the kitchen, the pole-mounted shelving system is a multitasker that's open to just about anything. The system is based on support poles in black or a stainless steel finish, which are available in tall and dresser unit heights. Elements such as glass and wood shelves can be mixed and matched to meet your personal needs. You can also add a touch of green to your shelves with plant units and grow lights. Choose shelves with integrated LED lights or set the stage with support poles featuring lights. The choice is entirely up to you!

RAILING SYSTEMS: UNBELIEVABLY VERSATILE

For us, good design is always solution-oriented. One of our favourite examples is our railing systems. These versatile all-rounders adapt to your needs and can create additional space in the kitchen, bathroom or living room.



SYSTEMATIC APPROACH TO OPENNESS: POSITION YOUR KITCHEN UTENSILS WHEREVER YOU PLEASE.

RAILING SYSTEMS

Our all-rounder – even in small spaces. Optimal for kitchens big and small, this system offers the perfect space for all your important kitchen utensils – so they're always within easy reach. Now's the time to configure your wall organisation system for your favourite utensils. The perfect match for your lifestyle and the kitchen.



SIGN EMOTION

Flexible storage space meets design! Shelf units in various widths and heights as well as special features and organisational aids provide Sign Emotion with an unbelievable degree of flexibility. Each and every element can be hooked or hung at any position and moved around on the rail. There are also a whole host of features to choose from such as the magnetic knife rack, special holders for tablets, coffee capsules and kitchen roll, as well as a variety of versatile shelves. An additional socket is also an option.

Music fans will enjoy the holder for the Teufel MUSICSTATION.





SIGN EMOTION RAILING SYSTEM

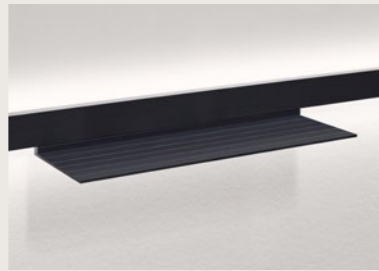

Universal storage shelf



Tablet holder



Small item tray



Capsule holder



Aluminium shelf unit with 1 or 4 shelves



Paper roll holder and towel rail



Universal storage shelf



Wine glass holder



Magnetic knife rack



Adapter holder for the Teufel MUSICSTATION



Distributor box



Double socket



Set of hooks

The aluminium profile and all the accessory elements are available in black and a stainless steel finish.



OTHER RAILING SYSTEMS

Railing with LED lighting



Black

Incl. 4 hooks for 600 mm width.
 Incl. 6 hooks for 900 mm width.
 Incl. 8 hooks for 1,200 mm width.

Railing set



Stainless steel finish

Incl. 1 profile strip and hook rail for 600 mm width.
 Incl. 2 profile strips, 1 hook rail and paper roll holder for 1,200 mm width.
 Incl. 3 profile strips, 1 hook rail, paper roll holder and multi-purpose shelf for 1,800 mm width.

Linero-MosaiQ railing system



Magnetic knife rack



Hook rail



Top shelf



Quiver/
herb pot



Dish, flat



Universal storage shelf with a height of 200 and 300 mm

200 mm model available with frame.



Paper roll holder



Cling wrap cutter



Tablet holder

The aluminium profile is available in a stainless steel finish.
 The corresponding accessory elements come in black graphite.

A WIDE RANGE OF LIGHTING SYSTEMS

Light changes everything and allows us to continue working at night. Always energy-efficient, the new LED lights for the kitchen come in many different forms and can be installed at many different locations. Emotion technology is suitable for any mood or requirement, ensuring seamless control across the board, from warm ambient lighting to bright light for work.

WORK LIGHTING

Clear, bright and focused – good lighting optimises work in the kitchen and enhances the atmosphere.

How about LED light panels and built-in lights integrated into the bottom shelf of tall units? Perfect for illuminating niches and worktops.

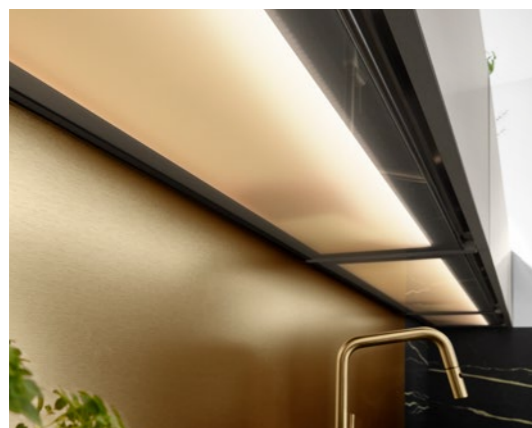

CEILING LIGHTS

The innovative light solution for kitchen islands.

The iLand LED ceiling light not only boasts extraordinary design, but can also provide direct or indirect illumination. Opt for a bright, glare-free working light to perfectly illuminate the work surface or hot plates with integrated extractor fan. Or enjoy a soft, atmospheric ambient light. iLand is controlled and dimmed by remote. Available in black or white to complement the look of your kitchen.



SET THE TONE WITH LED LIGHT: DIFFERENT LOCATIONS CREATE DIFFERENT EFFECTS.

AMBIENT LIGHT

Controlled lighting can provide a pleasant atmosphere. Make a statement with lighted shelves or lighting effects in wall units, the skirting board or the recessed handles. And suddenly everything feels warm and cosy.

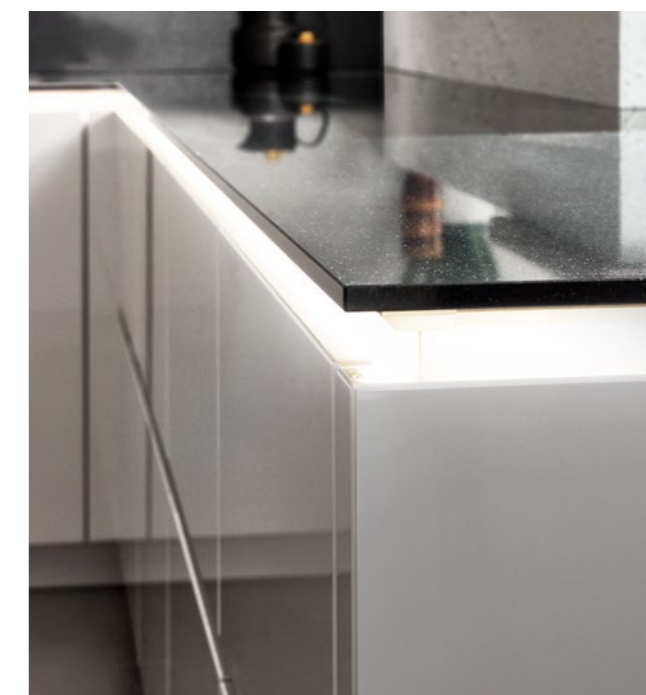

PRACTICAL ADDITIONS

Suitable additions can often increase convenience in the kitchen, which is why we're always developing cunning ideas to make daily life all the more pleasant as well as expanding our range, with a new variety of mobile, flexible and sometimes even entirely unexpected options.

NICHE SHELF UNIT WITH FLAP

These units will provide you with additional storage space in smaller areas. Small kitchen appliances, cutting boards, kitchen knives and more can simply disappear behind flap doors. Installation depth of 125 mm, body available in many different colours.

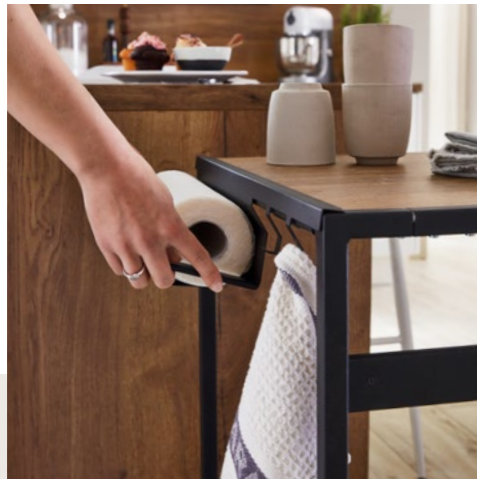

OUR TIP

Get your very own butler. The SERVE trolley table is always there whenever you need it, and offers storage shelves and space in a stylish package.



SOCKETS

Always there whenever you need them. Sockets for kitchen devices, smartphones and more can be positioned just about anywhere for easy access. Installed in the worktop or in niches, they simplify everyday work in the kitchen. Wireless charging offers a contemporary addition.



TARA STORAGE COMPARTMENT

For stowing all the odds and ends. Flush-mounted in the worktop, Tara can be closed off with a lid, offering an inconspicuous space solution for kitchen utensils and other small items. Available in black and a stainless steel finish.





INTERNAL TABLAR SHELF

An internal tablar shelf that can be integrated into tall and dresser units makes it a breeze to move kitchen devices around.



PLINTH DRAWER

Even the plinth offers storage space if you integrate the practical plinth drawer.



PULL-OUT TABLE

Space-saving solution for small kitchens. The base unit with pull-out table serves as a storage surface or a table for a coffee break. Maximum load 30 kg.



STEP STOOL

Open the drawer or pull-out, fold up the step stool and stow it away. But you can also hang the foldable aluminium step stool on the integrated universal bracket. Perfect for installation in base and tall units.



ELECTRIC ALL-PURPOSE SLICER

The electric all-purpose slicer makes preparing ingredients a breeze – and is suitable for a drawer width of 500 mm or more. When you're done, simply fold it up and stow it in a drawer to save space.

QUALITY FOR LIFE

We believe that only genuine quality can truly be sustainable, which is why we have made the decision to develop and produce our furniture exclusively in Germany. All the materials used undergo extensive testing with a focus on ensuring a service life of at least 15 years, and are inspected and certified by independent, international institutes. Quality that has won multiple awards and never fails to impress even years later.

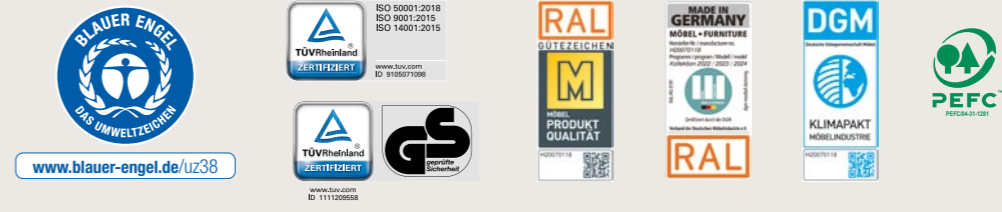



 /nobilia_de

 /nobilia_de

 /nobilia_official

nobilia-Werke
J. Stickling GmbH & Co. KG
Waldstraße 53-57
D-33415 Verl
info@nobilia.de
www.nobilia.de